

SWING SOLUTIONS & APPLICATIONS



- "CURVED" PROFILE 125mm
- STEREON[®] PROFILE 100mm

INnovationAL Solutions

"CURVED" PROFILE 125mm

swing door with top and bottom clamp profile

technical specifications

MAXIMUM DOOR DIMENSION	1,20m x 3,20m
GLASS THICKNESS	10-22mm
MAXIMUM GLASS WEIGHT	150Kg
FINISHING	
NATURAL ANODIZED, SATIN ANODIZED POWDER COATING	

INAL® glass swing door with top and bottom clamp profile without glass cuttings or drills (patented), with curved design external cover profile 125mm. A durable designed solution, up to 3,2 meters height, which provides extra safety and stability. Variety of glass applications (10mm -22mm), with three different sizes of heavy duty accessories according to the glass thickness. Available with lock mechanism in the bottom clamp for significant safety.

Available in do it yourself (DIY) or made to measure upon request.

system accessories

Available in DIY Kit

1116 SIDE END CAP

1230 UPPER PIVOT

1200-01 "CURVED" CLAMP PROFILE 125MM
INTERMETAL SA PATENT

PR200-19 "CURVED" Clamp Cover 125mm

1200-04 INTERNAL CLAMP SUPPORT

1220 LOWER BRACKET

1240 LOCK MECHANISM WITH CYLINDER (DOUBLE LOCK)

INTERMETAL SA PATENT

top pivot

floor spring

lock casing

weatherproofing

CODE 105	CODE 1229.HD.12	CODE 2020*	CODE PR200-24	CODE 113
RECTANGULAR TOP PIVOT	HEAVY DUTY RECTANGULAR TOP PIVOT D15MM	FLOOR SPRING SPEEDY M25	FLOOR BUSING STAINLESS STEEL	LOCK CASING STAINLESS STEEL (DOUBLE LOCKING)

	CODE 701 ALUMINUM BAR WITH BRUSH
	CODE 1412 PVC PROFILE WITH BRUSH
	CODE 1405 PVC PROFILE BUBBLE
	CODE 1409 PVC PROFILE WITH T-SHAPE FLEXIBLE

* or any floor spring from our range Catalogue "Glass Accessories"

clamp profile sizes

Available in **three different sizes** according to the glass thickness:

1. Glass Thickness **10-12mm**
2. Glass Thickness **14-15-16mm**
3. Glass Thickness **20-22mm**

Special profiles upon request



side end caps

PLASTIC SIDE END CAP



1116.10 FOR 10-12mm GLASS
1116.15 FOR 14-16mm GLASS
1116.20 FOR 20-22mm GLASS

top pivots

UPPER PIVOT ALUMINUM

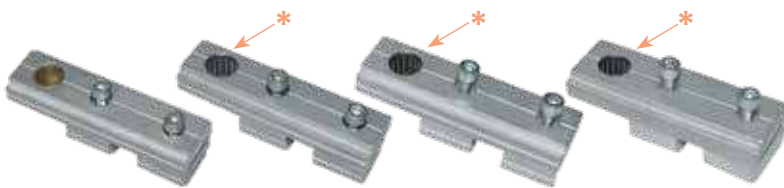

1230.10 FOR 10-12mm GLASS
1230.HD.12 HEAVY DUTY FOR 10-12mm GLASS
1230.HD.15 HEAVY DUTY FOR 14-16mm GLASS
1230.HD.20 HEAVY DUTY FOR 20-22mm GLASS

* With embedded bearing

brackets

LOWER BRACKET STAINLESS STEEL



1220.10 FOR 10-12mm GLASS
1220.15 FOR 14-16mm GLASS
1220.20 FOR 20-22mm GLASS

cross section

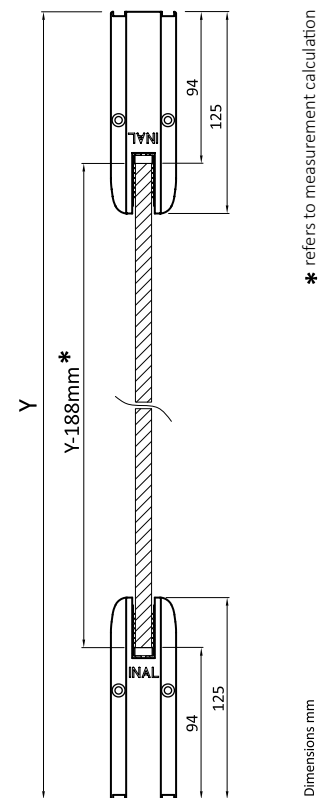

! Apply

THE SAME SYSTEM FOR FIXED GLASS PARTITIONS IN YOUR APPLICATIONS



1204 PROFILE "CURVED" FOR FIXED GLASS

STEREON® PROFILE 100mm

swing door with top and bottom clamp profile

technical specifications

MAXIMUM DOOR DIMENSION	1,00m x 3,00m
GLASS THICKNESS	10-22mm
MAXIMUM GLASS WEIGHT	120Kg
FINISHING	
NATURAL ANODIZED, SATIN ANODIZED POWDER COATING	

INAL® glass swing door with top and bottom STEREON® clamp profile 100 mm without glass cuttings or drills (patented).

A durable designed solution, up to 3 meters height, which provides extra safety and stability. Variety of glass applications (10mm-22mm), with three different sizes of heavy duty accessories according to the glass thickness. Available with lock mechanism in the bottom clamp for significant safety.

Available in do it yourself (DIY) or made to measure upon request.

system accessories







top pivot

floor spring

lock casing

weatherproofing

				
CODE 105	CODE 1229.HD.12	CODE 2020*	CODE PR200-24	CODE 113
RECTANGULAR TOP PIVOT	HEAVY DUTY RECTANGULAR TOP PIVOT D15MM	FLOOR SPRING SPEEDY M25	FLOOR BUSING STAINLESS STEEL	LOCK CASING STAINLESS STEEL (DOUBLE LOCKING)

	CODE 701 ALUMINUM BAR WITH BRUSH
	CODE 1412 PVC PROFILE WITH BRUSH
	CODE 1405 PVC PROFILE BUBBLE
	CODE 1409 PVC PROFILE WITH T-SHAPE FLEXIBLE

* or any floor spring from our range Catalogue "Glass Accessories"

clamp profile sizes

Available in **three different sizes** according to the glass thickness:

1. Glass Thickness **10-12mm**
2. Glass Thickness **14-15-16mm**
3. Glass Thickness **20-22mm**



side end caps

ALUMINUM SIDE END CAP



1110.10
FOR 10-12mm GLASS



1110.15
FOR 14-16mm GLASS



1110.20
FOR 20-22mm GLASS

top pivots

UPPER PIVOT ALUMINUM



1130.10
FOR 10-12mm GLASS

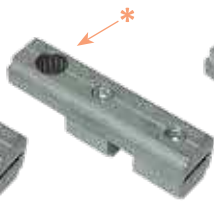

1130.HD.12
HEAVY DUTY
FOR 10-12mm GLASS

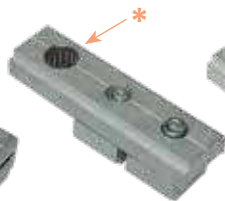

1130.HD.15
HEAVY DUTY
FOR 14-16mm GLASS

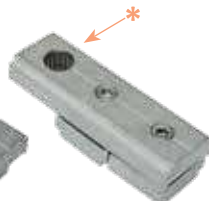

1130.HD.20
HEAVY DUTY
FOR 20-22mm GLASS

* With embedded bearing

brackets

LOWER BRACKET STAINLESS STEEL



1120.10
FOR 10-12mm GLASS



1120.15
FOR 14-16mm GLASS



1120.20
FOR 20-22mm GLASS

cross section

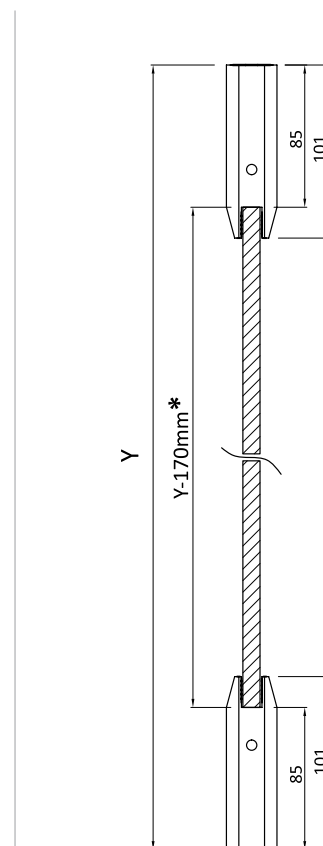

Dimensions mm

! Apply

STEREON® PROFILE
FOR THE FIXED GLASS
PARTITIONS OF YOUR
APPLICATIONS



1104
PROFILE FOR FIXED
GLASS STEREON®

"CURVED" PROFILE 125mm

bottom with mechanical lock & upper hinge

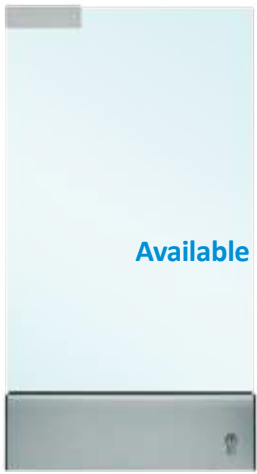

Available in DIY Kit

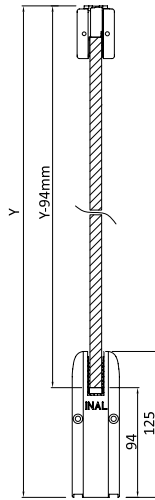

STEREON® PROFILE

bottom with mechanical lock & upper hinge



Available in DIY Kit

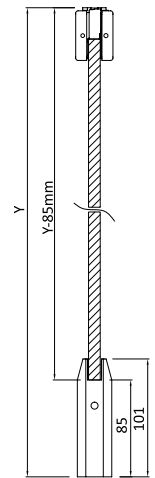

Dimensions mm

system accessories



system accessories

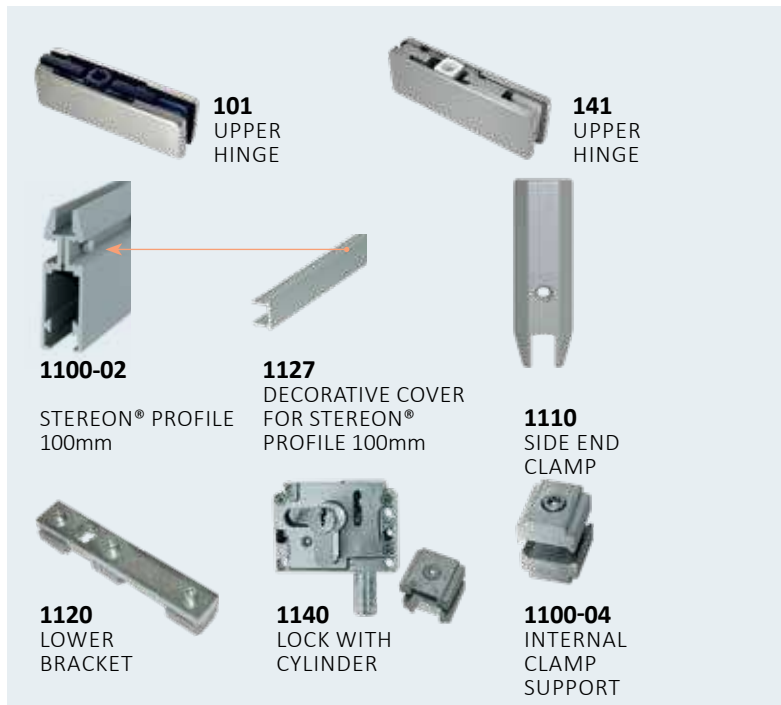

top pivot

floor spring

lock casing

weatherproofing

CODE 105	CODE 1229.HD.12	CODE 2020*	CODE PR200-24	CODE 113
RECTANGULAR TOP PIVOT	HEAVY DUTY RECTANGULAR TOP PIVOT D15MM	FLOOR SPRING SPEEDY M25	FLOOR BUSING STAINLESS STEEL	LOCK CASING STAINLESS STEEL (DOUBLE LOCKING)

	CODE 701 ALUMINUM BAR WITH BRUSH
	CODE 1412 PVC PROFILE WITH BRUSH
	CODE 1405 PVC PROFILE BUBBLE
	CODE 1409 PVC PROFILE WITH T-SHAPE FLEXIBLE

* or any floor spring from our range Catalogue "Glass Accessories"

electric locks

ONE WAY DOOR

295
ELECTROMAGNETIC LOCK
OPERATES WITH 12V DC



INSTALLATION
IN ROOF
OR METAL BEAM

DOUBLE ACTION DOOR AL/R

298
ELECTROMAGNETIC LOCK
OPERATES WITH 12V DC



INSTALLATION
IN ROOF
OR METAL BEAM

accessories for electric locks



296
RECEIVER
WITH REMOTE
CONTROL



1700
REMOTE
CONTROL



299E
KEYBOARD
& CARD
READER



293
CARD



294E
TRANSFORMER
12V DC



258
TRANSFORMER 12V
DC KIT



259
TRANSFORMER 12V DC
KIT WITH RECEIVER &
REMOTE CONTROL



291A
BUTTON
(INTERNAL
USE)



291C
BUTTON
(INTERNAL
USE)



291B
BUTTON
(INTERNAL
USE))



291MH
WIRELESS
INFRARED
TOUCHLESS
SWITCH



291MHW1
ONE [1] WIRELESS INFRARED
TOUCHLESS SWITCH WITH
RECEIVER



291MHW2
TWO [2] WIRELESS INFRARED
TOUCHLESS SWITCHES WITH RECEIVER

SWING SOLUTIONS & APPLICATIONS

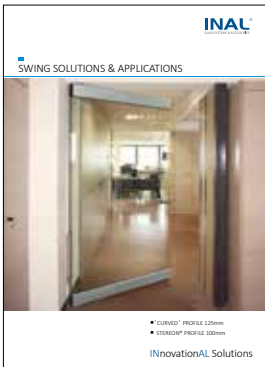

ALSO DOWNLOAD OUR PRODUCT CATALOGUES

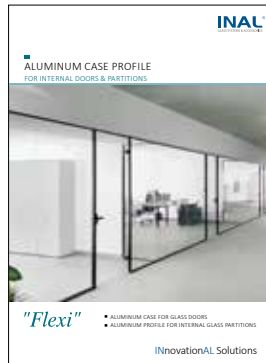
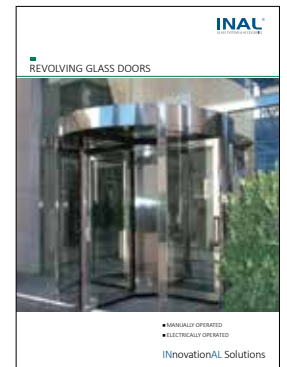
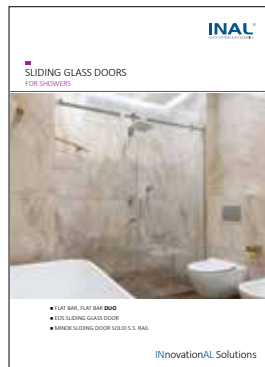

INnovationAL Solutions